

ORIGINAL RESEARCH ARTICLE

OPEN ACCESS

THERMODYNAMIC INVESTIGATION OF THE HYDROGEN PRODUCTION BY STEAM REFORMING OF THE BIOGAS FROM MANIPUEIRA

1,*Jonni Guiller Ferreira Madeira, ²Angel Ramon Sanchez Delgado, ²Eluã Ramos Coutinho, ¹Elizabeth Mendes de Oliveira, ¹Vanessa de Almeida Guimarães, ²Vinícius Oliveira de Araújo and ¹Marcus Val Springer

¹Group of Nanoscience and Environment, Mechanical Engineering Department, Federal Center of Technological Education of Rio de Janeiro-CEFET/RJ, Areal Street, 522 - Mambucaba Park, Angra dos Reis -RJ, 23953-030

²Federal Rural University of Rio de Janeiro-UFRRJ, Rodovia BR 465 - Km 7 - Campus Universitário - Zona Rural, Seropédica - RJ, 23851-970

ARTICLE INFO

Article History:

Received 04th September, 2018
Received in revised form
09th October, 2018
Accepted 13th November, 2018
Published online 26th December, 2018

Key Words:

Hydrogen,
Exergy analysis,
Economic analysis,
Cassava wastewater,
Bioenergy.

ABSTRACT

The use of renewable energy has become a necessary alternative to reduce the emission of polluting gases in the atmosphere. Hydrogen is a promising alternative fuel and its use has increased in the last decade. There are different ways of producing hydrogen, however there are few reports in the literature on the production of biohydrogen using waste water from the processing of cassava (manipueira). This study discusses the exergetic efficiency of the biohydrogen production using a large factory production plant using the HYSYS process simulation software (version 8.0). Exergy is a part of the energy used to become useful and, therefore, linked to an economic perspective of an adjusted project. The exergetic analysis revealed that the steam reformer and the steam generator are the most inefficiently equipment of the exergetic point of view. The overall efficiency of the simulated plant is 73.71%, which represents a value very similar to reports in the literature of hydrogen production, by steam reforming, using other kinds of fuels. Finally, we can conclude that the production of H₂ by steam reforming can be a viable alternative, considering the good exergetic performance of the plant.

Copyright © 2018, Jonni Guiller Ferreira Madeira et al. This is an open access article distributed under the Creative Commons Attribution License, which permits unrestricted use, distribution, and reproduction in any medium, provided the original work is properly cited.

Citation: Jonni Guiller Ferreira Madeira, Angel Ramon Sanchez Delgado, Eluã Ramos Coutinho, et al., 2018. "Thermodynamic investigation of the hydrogen production by steam reforming of the biogas from Manipueira", *International Journal of Development Research*, 8, (12), 24455-24459.

INTRODUCTION

The development of sustainable technologies for the production of bioenergy has become an attractive alternative to the energy sector since it reduces emissions from polluting gases (Wang *et al.*, 2015). In the world and in Brazil the need to change the energy matrix has provided many opportunities for the insertion of this form of energy generation. Most countries invest a lot of resources to develop technologies to produce bioenergy from cellulosic raw materials. In this case, Brazil is the world's largest producer of ethanol (clean and renewable biofuels commonly used in the transportation sector) from sugarcane. Other biofuels such as biodiesel (obtained from vegetable oils, animal fats, algae) have been used in various proportions (5% and 20%) with diesel

(Arantes Felício *et al.*, 2015) in the transportation and generation sector of electric and thermal energy in a decentralized way. The production of biohydrogen from manipueira (effluent produced in cassava processing) has been taken on strength in recent years (Anyanwu *et al.*, 2015, Chaleomrum *et al.*, 2014; Madeira *et al.*, 2017b), becoming an economically competitive option. The main part of cassava production in Brazil destined to the production of flour, about 60% of the production (Bianchi and Cereda, 1999) was calculated on the main derivative of cassava flour, consumed basically in all Brazilian territory, but specifically in the North and Northeast. There are some companies in Brazil that produce cassava flour, mainly in the states of Mato Grosso do Sul, Santa Catarina, Paraná and São Paulo. A factory with a capacity to process up to 22,000 t/d is considered a large industry (Souza, 2001). The proposal to supply hydrogen from the biogas from the energy solution is a kind of technology that promises to produce energy. Firstly, to use cassava wastewater biogas as fuel for hydrogen production, it is first

*Corresponding author: Jonni Guiller Ferreira Madeira,
Group of Nanoscience and Environment, Mechanical Engineering Department,
Federal Center of Technological Education of Rio de Janeiro-CEFET/RJ,
ArealStreet, 522 - Mambucaba Park, Angra dos Reis -RJ, 23953-030.

necessary to attest its exergetic viability. The exergetic efficiency and cost of hydrogen production are factors that determine the profitability of the hydrogen production plant (Madeira *et al.*, 2017a). Many authors have used the exergetic analysis to quantify the technical viability of an energy production process (Orhan *et al.*, 2010; Tsatsaronis *et al.*, 2008; Kalinci *et al.*, 2011). Costs associated to the products generated in a small effluent treatment plant applying the thermo-economic method based on the functional diagram was obtained by (Lamas *et al.*, 2009). Effluents are considered as a source of energy in the form of heat for the operation of systems that operate as heat pumps, in this sense a review of studies that consider energy, exergic, economic and environmental aspects was developed by (Hepbasli *et al.*, 2014). The aims of this study is the exergetic analysis of each equipment of the plant of production of H₂ by steam reforming of biogas from manipueira, in order to evaluate the exergetic viability of the project.

MATERIALS AND METHODS

The process simulation was performed from HYSYS (version 8.0). The computational simulation provides the thermodynamic parameters used in the exergetic analysis. From the exergetic analysis it is possible to qualify and quantify the maximum amount of useful energy in each one of the equipment of the plant in order to indicate the equipment with greater or lesser efficiency.

HYSYS software and thermodynamic models: Computer process simulations are powerful tools for solving mathematical models related to physical processes. The process simulation allows you to test different scenarios before making a project becomes real. There are several industrial process simulation software, such as Aspen Plus, Chemcad, Hysys, etc. For this study was used Hysys, which simulates a H₂ by steam reforming production plant, was used in this study.

This study was made based on a large industry that use 73,300 t/d of cassava root, equivalent a production of 22,000 t/d of cassava flour and a production of 6,600,000 l/d of cassava wastewater (Fernandes Junior and Takahashi, 1994). The calculation of thermodynamic equilibrium system is performed through the minimization of the Gibbs free energy (Alshammari and Hellgardt, 2014 and; Martínez *et al.*, 2013; Soltani *et al.*, 2014).

Madeira *et al.*, 2017a describe each step for this kind of simulation using Hysys:

- Set the main chemical components (methane, hydrogen, carbon monoxide, carbon dioxide and water steam) used in the process, which can be accessed through the database of the software;
- Choose the appropriate thermodynamic model for the development of the study. In this case, the PSRK (Predictive Soave-Redlich-Kwong) (Authayanun *et al.*, 2011) was chosen;
- Set the volume of biogas to be reformed, operation parameters of the plant equipment (see Table 1), and the main thermodynamic properties (flow, temperature, and pressure).

Description of the process: Figure 1 shows the diagram of a plant of hydrogen production from biogas obtained in the fermentation of cassava wastewater.

A two-phase anaerobic biodigester was used, under the follows conditions:

- Temperature 32 °C.
- The pH was maintained between 5.5 and 6.0 (corrected with an alkaline solution (NaOH)).
- Cassava wastewater was used as substrate (bovine manure was diluted to the substrate).

Table 1. Description of the operating conditions of equipments in different processes of the plant

Processes	Conditions	References
Steam Reformer	2.5:1 ratio of steam/methane 700 °C of temperature to reform and 101.3 kPa of pressure to reform	(Wang <i>et al.</i> , 2016; Soltani <i>et al.</i> , 2014)
Steam Generator	20% excess of air, efficiency of 90%	(Lora and Nascimento, 2014)
Shift Reactor	High temperature shift reactor 350 °C e low temperature shift reactor 200 °C	(Braga <i>et al.</i> , 2013)
Purification of hydrogen by pressure swing adsorption (PSA)	Te Temperature 38 °C, Pressure 101.3kPa	(Soltani <i>et al.</i> , 2014)

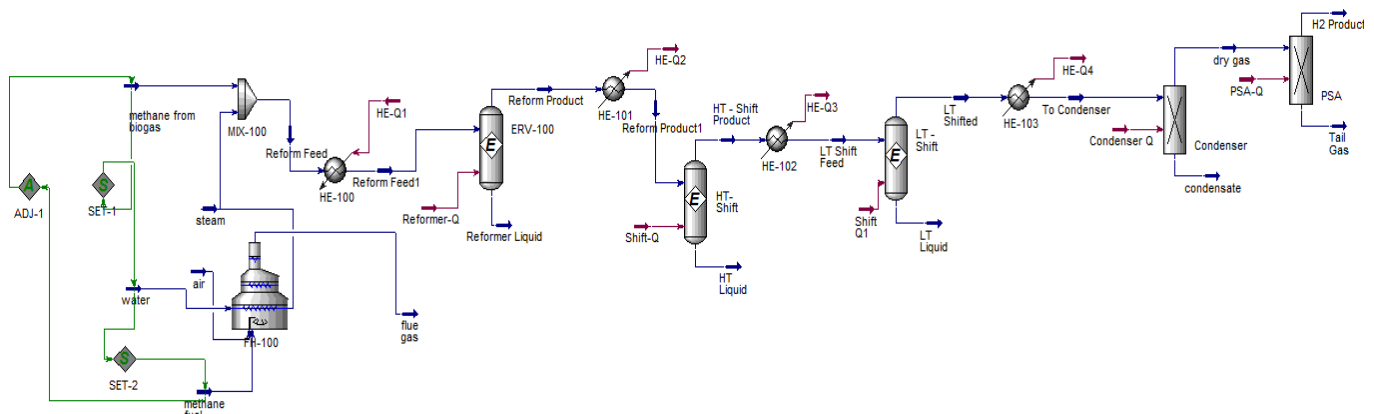

Figure 1. Plant of the hydrogen production process through the steam reforming of the biogas obtained in the fermentation of cassava wastewater

According to Lacerda (1991), the biogas produced from cassava wastewater fermentation, determined through gas chromatography, has a composition of 75, 5% of CH₄.

The biogas produced by Lacerda (1991) was used as raw material in the steam reforming process to obtain hydrogen. This reform process has two steps: high-temperature steam reform and reform in reactors of change. The main reactions involved in the steam reforming process are described below:

✓ Global Reforming Reaction (Boloy, 2014):

The global reaction of conversion of the fuel into hydrogen through steam reforming is shown in equation (1):

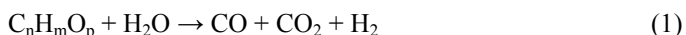

Equation 2 shows the steam reforming of the biogas in its global form (Corigliano and Fragiaco, 2015):



Many chemical reactions may occur simultaneously to the steam reforming reaction and are presented in equations (3), (4), (5), (6), (7) and (8) (Italiano, *et al.*, 2015):

✓ Water-gas shift reaction:

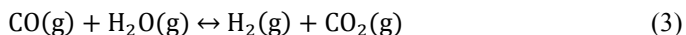

✓ Methanation reaction:

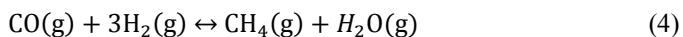

✓ Boudouard reaction:

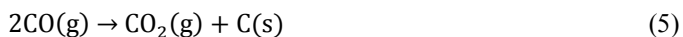

✓ Dry methane reforming:

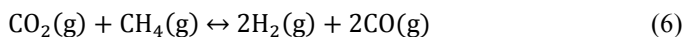

✓ Cracking reaction:



✓ Steam production:

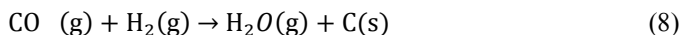

Exergetic Analysis

Exergy for a system is the maximum useful work that can be obtained from its initial state for the thermodynamic equilibrium with the environment (Kotas, 1980). The idea of exergy is widely used in thermal systems, being able to gauge how efficient a given system is and thus suggest improvements in the process. The concepts of energy analysis and exergetic analysis are very similar, but they deal differently in relation to the conservation of energy of a given process. While the first one is described by the first law of thermodynamics, which deals with the idea of energy conservation, the second one, in turn, says that part of the energy involved in some process may simply not be useful, that is: it cannot be used for perform work and, consequently, there is loss of exergy during this process. The exergetic equilibrium allows a broader view of the problem in question, avoiding conclusions based only on

the application of the first law of thermodynamics (Madeira *et al.*, 2017a).

Exergy associated with stream

To achieve exergy balance in a system or process, it is necessary to calculate three types of exergy: exergy associated with flow of matter, heat transfer and exergy associated with work. Lastly, the irreversibilities of the system also need to be calculated. The total exergy, equation 9, associated with a certain flow of matter can be divided into four components: physical, kinetic, potential and chemical (Kotas, 1980), without considering the nuclear, magnetic and electrical effects of surface tension. In the present study, the analysis will delimited to only physical and chemical exergy.

$$E_\chi = E_{\chi_{PH}} + E_{\chi_{CH}} + E_{\chi_{KN}} + E_{\chi_{PT}} \quad (9)$$

Where:

E_χ : Total Exergy (kW)
 $E_{\chi_{PH}}$: Physical Exergy (kW);
 $E_{\chi_{CH}}$: Chemical Exergy (kW);
 $E_{\chi_{KN}}$: Kinetic Exergy (kW);
 $E_{\chi_{PT}}$: Potential Exergy (kW).

Physical Exergy

Kotas (1985) defines physical exergy as the maximum obtainable amount of work when a flow is brought from its initial state, in which temperature and pressure are defined by T and P, respectively, to the reference state, defined by P₀ and T₀, through physical processes involving only thermal interactions with the environment. Physical exergy can be described by equation 10.

$$E_{\chi_{PH}} = (h - h_0) - T_0(s - s_0) \quad (10)$$

Where:

h: enthalpy (kJ/kg);
s: entropy (kJ/kg °C);
h₀: enthalpy at reference state conditions (kJ/kg);
s₀: entropy at reference state conditions (kJ/kg °C);
T₀: temperature at reference state conditions (°C);
 $E_{\chi_{PH}}$: Specific physical exergy (kJ/kg).

Chemical Exergy

Chemical exergy can be defined alternatively as the minimum theoretical work to form an amount of matter from the substances present in the environment through reversible processes Szargut (1988). The method to calculate the standard chemical exergy of different substances, equation 11, was developed by Szargut (1980).

$$E_{\chi_{CHi}}^0 = \Delta_f G_i^0 - \sum_i \nu_i E_{\chi_{CHj}}^0 \quad (11)$$

Where:

$E_{\chi_{CHi}}^0$: Standard chemical exergy of specie i (kJ/mol);
 $E_{\chi_{CHj}}^0$: Standard chemical exergy of element j (kJ/mol)
 $\Delta_f G_i^0$: Variation of Gibbs free energy of each i species (kJ/mol).

According to Szargut (1988), the chemical exergy of a flow, in the case of a mixture of species, can be calculated by equation 12:

$$E\chi_{CH} = L_0 \sum_{i=1}^n \chi_{0,i} E\chi_{CH,i}^{OL} + V_0 \sum_{i=1}^n \gamma_{0,i} E\chi_{CH,i}^{OV} \quad (12)$$

Where:

$E\chi_{CH}$: Specific chemical exergy (kJ/kg);

$E\chi_{CH,i}^{OL}$: Standard chemical exergy of species i in liquid phase (kJ/kg);

$E\chi_{CH,i}^{OV}$: Standard chemical exergy of species i in vapor phase (kJ/kg);

L_0 : Liquid fraction;

V_0 : Vapor fraction;

$\chi_{0,i}$: Liquid fraction of each species i ;

$\gamma_{0,i}$: Vapor fraction of each species i .

Rational Efficiency

In the literature, there are various definitions of exergetic efficiency of a system. Ramesh *et al.* (2015) used the definition of exergetic efficiency, also called rational efficiency or Boskanovic, as being the ratio between total exergy that leaves a system and the total exergy that enters a system. This efficiency can be quantified by equation 13:

$$\eta = \frac{\sum_{i=1}^n E\chi_{si}}{\sum_{i=1}^n E\chi_{ei}} \quad (13)$$

Where:

η : Rational Efficiency

$E\chi_{ei}$: Total exergy that leaves a system;

$E\chi_{si}$: Total exergy that enters a system.

Exergetic efficiency

Tsatsaronis (1993) describes exergetic efficiency as being the ratio between the exergy that leaves the system (product) and the exergy that is used in the system (fuel), equation 14, a definition widely used to evaluate systems:

$$\xi = \frac{E\chi_P}{E\chi_F} \quad (14)$$

Where:

ξ : Exergetic Efficiency;

$E\chi_P$: Product exergy (kW);

$E\chi_F$: Fuel exergy (kW).

Results of Exergetic Analysis

The production of biohydrogen represents a potential technology to innovate the cassava production chain, since it will add values to cassava because the manipueira produced in the process has no commercial value. The exergy analysis, besides indicating the inefficiency of a given process also allows to compare different technological processes. The results obtained in the study are described below:

Technological improvements in steam reformer could improve the yield of the plant, considering that the reformer is one of

the most responsible for the exergetic destruction in the plant (Figure 2). The input heat flow (HE-Q1) in the mixer (MIX-100) preceding the reformer is largely responsible for the inefficiency of the equipment, since the steam reformer requires a large amount of heat to perform the reform. The steam generator is also an equipment with great inefficiency in the exergetic point of view, because the steam production, generates the increase of the entropy and, consequently, the increase of the exergetic destruction. It was found the value of 73.71%, for global exergetic efficiency, this process demonstrates results similar to those reported by Madeira *et al.*, (2017a), Boloy *et al.*, (2015) and Coronado (2013).

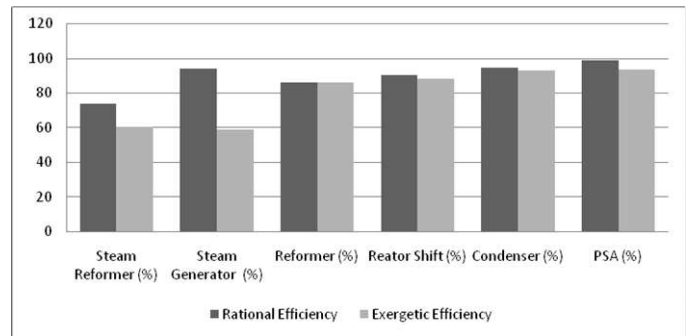

Figure 2. Exergetic and Rational efficiency of the plant compared to the methane concentration of the biogas

Conclusion

Cassava is a commodity of extreme importance for several developed countries, because it is a food largely consumed in these countries and has a low production cost. The process of steam reforming of biogas from the mango tree to produce H_2 is an alternative that is feasible from the exergetic point of view and also contributes to the reduction of the environmental impact caused by the use of biogas. Heat power of biogas comes from methane and this, in turn, is 21 times more pollutant than carbon dioxide. The present study carried out the economic and exergetic analysis in a cassava wastewater plant. In the study of exergetic efficiency, most of the irreversibilities of the productive process occur in the steam reformer and in the steam generator, so they are equipment that could be realized technological improvements in order to diminish the destruction of exergy. Thus, the global exergetic efficiency of the plant is similar to other steam reforming plants reported in the literature, since methane from the manipueira has a high methane content, allowing the production of a large amount of H_2 . The manipueira, in general, is discarded and has no commercial value, so the use of this residue can add values to the production of cassava derivatives (such as dry flour and starch), enabling the increase of income for producers of this commodity.

Acknowledgements: The financial support provided by the Federal Center of Technological Education of Rio de Janeiro-CEFET/RJ and PPGCTIA (Doctoral Program in Science, Technology and Innovation in Farming), Postgraduate Program of Federal Rural University of Rio de Janeiro.

REFERENCES

Alshammari, Y.M., Hellgardt, K. 2014. A new HYSYS model for underground gasification of hydrocarbons under hydrothermal conditions. *Int. J. Hydrogen Energy*, 39, 12648–12656. doi:10.1016/j.ijhydene.2014.05.182.

- Anyanwu, C.N., Ibeto, C.N., Ezeoha, S.L., Ogbuagu, N.J. 2015. Sustainability of cassava (*Manihot Esculenta* Crantz. as industrial feedstock, energy and food crop in Nigeria. *Renew. Energy* 81, 745–752. doi:10.1016/j.renene.2015. 03.075.
- Arantes Felício, A., Martins Parente, T.E., Regina Maschio, L., Nogueira, L., Rodrigues Venancio, L.P., de Freitas Rebelo, M., Schlenk, D., de Almeida, E.A. 2015. Biochemical responses, morphometric changes, genotoxic effects and CYP1A expression in the armored catfish *Pterygoplichthys anisitsi* after 15 days of exposure to mineral diesel and biodiesel. *Ecotoxicol. Environ. Saf.*, 115, 26–32. doi:10.1016/j.ecoenv.2015.01.034.
- Authayanun, S., Arpornwichanop, A., Patcharavorachot, Y., Wiyaratn, W., Assabumrungrat, S. 2011. Hydrogen production from glycerol steam reforming for low- and high-temperature PEMFCs. *Int. J. Hydrogen Energy*, 36, 267–275
- Bianchi, V.L., Cereda, M.P. 1999. Mass balance of a medium-sized cassava flour factory in the State of São Paulo. *Rev. Energia na Agricultura.*, 14, 113. São Paulo.
- Boloy, R. A. M., Ferrán, S. J. R., e Penalva, D. D. C. L., Corrêa, C., Angulo, J. A. P. and de Castro Pereira Filho, R 2015. Exergetic evaluation of incorporation of hydrogen production in a biodiesel plant. *International Journal of Hydrogen Energy*, 40(29), 8797-8805.
- Boloy, R.A.M. 2014. Ecological and Thermo-economic Analysis of the Incorporation of Hydrogen Production Process in a Biodiesel Plant [WWW Document]. URL <http://www.athena.biblioteca.unesp.br/exlibris/bd/cathedra/10-02-2015/000807542.pdf>.
- Braga, L.B., Silveira, J.L., Evaristo da Silva, M., Machin, E.B., Pedroso, D.T., Tuna, C.E. 2013. Comparative Analysis Between A Pem Fuel Cell And An Internal Combustion Engine Driving An Electricity Generator: Technical, Economical And Ecological Aspects. *Appl. Therm. Eng.* doi:<http://dx.doi.org/10.1016/j.applthermaleng.2013.10.053>
- Chaleomrum, N., Chookietwattana, K., Dararat, S. 2014. Production of PHA from Cassava Starch Wastewater in Sequencing Batch Reactor Treatment System. *APCBEE Procedia* 8, 167–172. doi:10.1016/j.apcbee.2014.03.021.
- Corigliano, O., Fragiaco, P. 2015. Technical analysis of hydrogen-rich stream generation through CO₂ reforming of biogas by using numerical modeling. *Fuel.*, 158, 538–548. doi:10.1016/j.fuel.2015.05.063.
- Coronado CR, Tuna CE, Zanzi R, Vane LF, Silveira JL. 2013. Development of a thermo-economic methodology for the optimization of biodiesel production Part I: biodiesel plant and thermo-economic functional diagram. *Renew Sustain Energy Reviews*; 23:138-46. <http://dx.doi.org/10.1016/j.rser.2013.02.015>.
- Fernandes Junior, A., Takahashi, M. 1994. Tratamento da manipueira por processos biológicos – aeróbio e anaeróbio. In: Cereda *et al.*, *Industrialização da mandioca*. São Paulo: Ed. Paulicéia, 174p.
- Hepbasli, A., Biyik, E., Ekren, O., Gunerhan, H., Araz, M. 2014. A key review of wastewater source heat pump (WWSHP) systems. *Energy Convers. Manag.*, 88, 700–722. doi:10.1016/j.enconman.2014.08.065.
- Italiano, C., Vita, A., Fabiano, C., Laganà, M., Pino, L.(2015). Bio-hydrogen production by oxidative steam reforming of biogas over nanocrystalline Ni/CeO₂ catalysts. *Int. J. Hydrogen Energy*, 40, 11823–11830. doi:10.1016/j.ijhydene.2015.04.146.
- Kalinci, Y., Hepbasli, A. and Dincer, I. 2011. Exergoeconomic analysis of hydrogen production from plasma gasification of sewage sludge using specific exergy cost method. *International Journal of Hydrogen Energy*, 36(17), pp.11408-11417.
- Kalinci, Y., Hepbasli, A. and Dincer, I. 2011. Exergoeconomic analysis of hydrogen production from plasma gasification of sewage sludge using specific exergy cost method. *International Journal of Hydrogen Energy*, 36(17), pp.11408-11417.
- Kotas T.J. 1980. Exergy concepts for thermal plant. *Int J Heat Fluid Flow*; 2:105e14.[http://dx.doi.org/10.1016/0142-727x\(80\)90028-4](http://dx.doi.org/10.1016/0142-727x(80)90028-4).
- Kotas, T. J. 1985. “The Exergy Method of Thermal Plants Analysis”. Krieger publishing company, Florida, original edition 1985, reprint in 1995, Florida, USA.
- Lacerda, T. H. M. 1991. Kinetic study of the methanogenic phase of cassava wastewater substrate. 114p. PhD Thesis – University of Agronomic Science, State University Paulista, Botucatu – SP.
- Lamas, W.Q., Silveira, J.L., Giacaglia, G.E.O., Reis, L.O.M. 2009. Development of a methodology for cost determination of wastewater treatment based on functional diagram. *Appl. Therm. Eng.*, 29, 2061–2071. doi: DOI 10.1016/j.applthermaleng.2008.10.018.
- Lora, E. E. S., Nascimento, M. A. R. D. 2004. Thermoelectric generation: planning, design and operation. Rio de Janeiro: Interciência, v. 2, p. 2.
- Madeira, J.G.F., Boloy, R.A.M., Delgado, A.R.S., Lima, F.R., Coutinho, E.R. and de Castro Pereira Filho, R. 2017b. Ecological analysis of hydrogen production via biogas steam reforming from cassava flour processing wastewater. *Journal of Cleaner Production*.
- Madeira, J.G.F., Delgado, A.R.S., Boloy, R.A.M., Coutinho, E.R. and Loures, C.C.A. 2017a. Exergetic and economic evaluation of incorporation of hydrogen production in a cassava wastewater plant. *Applied Thermal Engineering*.
- Martínez, I., Romano, M.C., Chiesa, P., Grasa, G., Murillo, R. 2013. Hydrogen production through sorption enhanced steam reforming of natural gas: Thermodynamic plant assessment. *Int. J. Hydrogen Energy.*, 38, 15180–15199. doi:10.1016/j.ijhydene.2013.09.062.
- Orhan, M.F., Dincer, I. and Rosen, M.A. 2010. Exergoeconomic analysis of a thermochemical copper–chlorine cycle for hydrogen production using specific exergy cost (SPECOC) method. *Thermochimica Acta*, 497(1), pp.60-66.
- Ramesh S, Yang E-H, Jung J-S, Moon DJ. 2015. Copper decorated perovskite an efficient catalyst for low temperature hydrogen production by steam reforming of glycerol. *Int J Hydrogen Energy.*, <http://dx.doi.org/10.1016/j.ijhydene.2015.02.013>.
- Soltani, R., Rosen, M. A., Dincer, I. 2014. Assessment of CO₂ capture options from various points in steam methane reforming for hydrogen production. *Int. J. Hydrogen Energy.*, 39, 20266–20275. doi:10.1016/j.ijhydene.2014. 09.161.
- Souza, E.F., Staduto, A.R., da Rocha Júnior, W.F. and Rinaldi, R.N. 2011. The cassava culture in the western region of Paraná: a study of chain coordination from the point of view of contract theory.
- Szargut J. 1980. International progress in second law analysis. *Energy*; 5:709e18.[http://dx.doi.org/10.1016/0360-5442\(80\)90090-0](http://dx.doi.org/10.1016/0360-5442(80)90090-0).
- Szargut, J., Morris, D, Steward, F. 1988. Exergy analysis of thermal, chemical, and metallurgical processes. New York: Hemisphere Publishing Corporation.
- Tsatsaronis G. 1993. Thermo-economic analysis and optimization of energy systems. *Prog Energy Combust Sci*; 19:227e57. [http://dx.doi.org/10.1016/0360-1285\(93\)90016-8](http://dx.doi.org/10.1016/0360-1285(93)90016-8).
- Tsatsaronis, G., Kapanke, K. and Marigorta, A.M.B. 2008. Exergoeconomic estimates for a novel zero-emission process generating hydrogen and electric power. *Energy*, 33(2), pp.321-330.
- Wang, *et al.*, Fu, S., Guo, G., Jia, Z.Z., Luo, S.J. and Guo, R.B. 2016. Experimental study on hydrate-based CO₂ removal from CH₄/CO₂ mixture. *Energy*, 104, pp.76-84.